

co
ro

INDICE / CONTENTS

<i>Nest</i>	05
<i>Sabal</i>	24
<i>Maze</i>	30
<i>OBQ / OPQ</i>	35
<i>Pergola</i>	39
<i>Jubeae</i>	43
<i>L3</i>	53
<i>SG1</i>	59
<i>Shot</i>	81
<i>Zeta</i>	87
<i>Fellini</i>	93
<i>Loop</i>	97
<i>Doccia / Shower</i>	99
<i>BBQ</i>	101
<i>Fioriere / Flower pots</i>	102

CORO, TEMPO DA VIVERE IN LIBERTÀ - TIME TO LIVE IN FREEDOM

Le cose hanno un valore quando servono per vivere. Vivere meglio. La raffinatezza può identificarsi con la semplicità, o la ricchezza con la più essenziale delle forme. Sono maniere diverse di rappresentare l'idea di bellezza. E un bell'oggetto avrà sempre la qualità di arricchirci. A noi importa il tempo che viviamo, al meglio delle possibilità, secondo una personale idea di libertà. Lo vogliamo pieno di energia, vivo di sensazioni, nostro. Dare una forma al piacere di vivere: sotto questo segno cresce il marchio Coro. Lavoriamo per creare oggetti capaci di valorizzare il tempo, oggetti che accompagnano i ritmi diversi della giornata. Ognuno di essi è una nota della nostra maniera di stare al tempo, di inventare la musica del momento. Nel concerto degli elementi che a noi si intonano. Mobili in senso proprio, che stanno bene dovunque, in casa e in giardino. Libera interpretazione del tema interno/esterno.

.....

Things are precious to us when they allow us to live to live better. Sophistication is simplicity, and richness is minimalism. These are different expressions of beauty. And beauty will always enrich our lives. Moments when we live life to the full, according to our own personal concept of freedom, are important to us. We want those moments to be energised, sensual, ours. Coro keeps giving form to the pleasure of living. We create things which enrich time, which accompany the changing moods of every day. Each object sounds a note in our manner of keeping to the rhythm of time, inventing music for each moment. All as part of the concert of elements resounding in tune with us. It is furniture in the real sense, which can go anywhere, inside or outside. A free interpretation of the interior/ exterior theme.



NEST

design Stefano Gallizioli

Un divano in versione angolare, che diventa rifugio accogliente come un nido, dove potersi sdraiare. È arricchito da morbidi cuscini per un maggiore comfort. L'elemento caratterizzante è lo schienale in tubolare, la struttura è in acciaio inox satinato, rivestito in PVC rinforzato nylon. Può essere completato da un pouf quadrato, creando un angolo chaise longue o dall'accostamento di due sedute, per una scenografia elegante. Possono essere interpretati in versione monocolora o con abbinamenti in contrasto, attraverso la gamma di tessuti per esterno che li rivestono.

A corner sofa, that looks like a welcoming nest where to lie down in, with some loose cushions placed on to make it even more comfortable. Satin stainless steel frame, covered by reinforced PVC nylon cord on the backrest. The sofa can be combined with a square ottoman to create a chaise longue or two seats, for creating an elegant sitting. Covers and cushions are available in a single colour or in different colours with a special dedicated fabric for outdoor use.





Divano lineare 270
Linear sofa 270



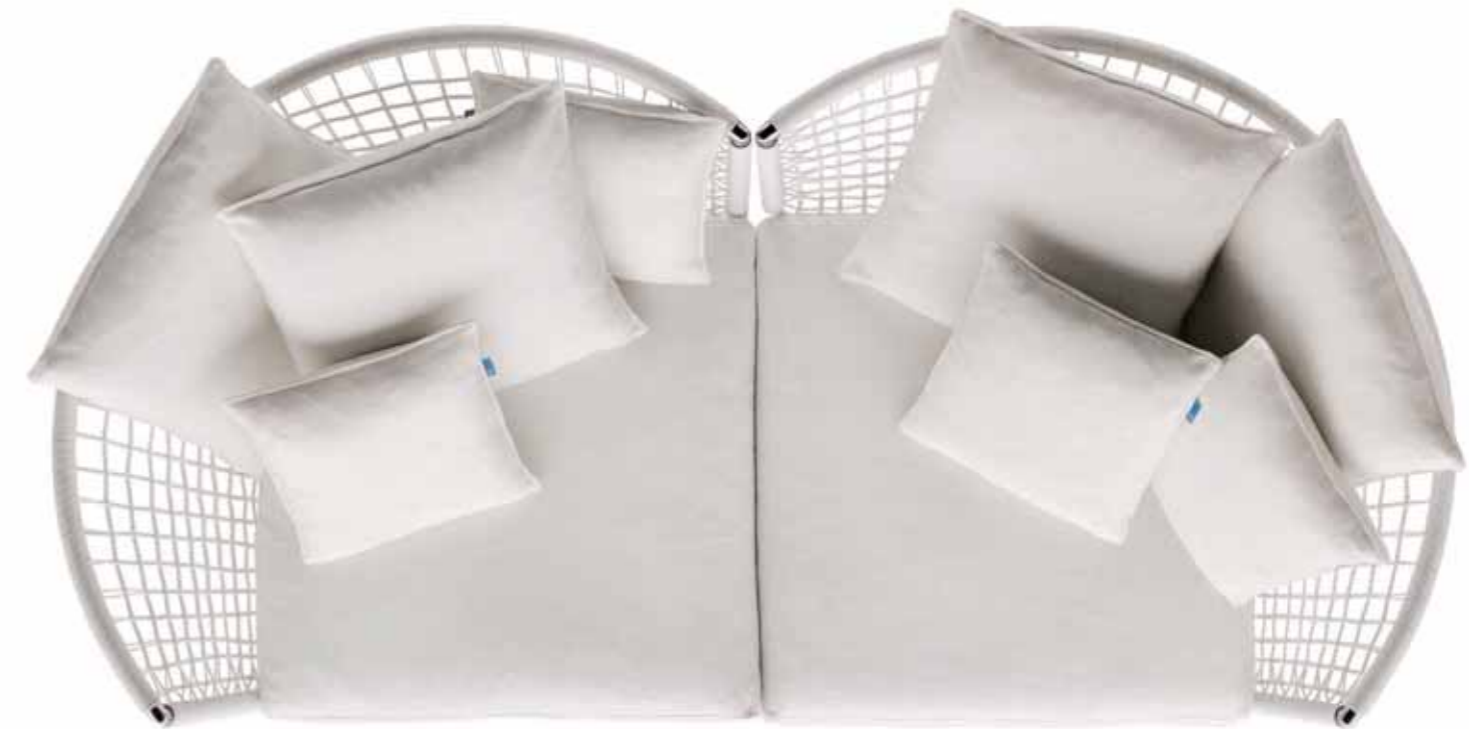

Divano circolare 90/120
Circular sofa 90/120





Divano lineare 120
Linear sofa 120



Chaise longue



Poltrona
Armchair







SABAL

design Matteo Nunziati

Il rapporto oggetto – ambiente è diventato sempre più importante per determinare la qualità di quello che “disegniamo” e “progettiamo” usare il tratto leggero permette una creativa fusione di gusto ed equilibrio.
Non vogliamo semplicemente produrre un elemento, vogliamo vivere con esso.

The relationship between an object and its surroundings has become increasingly important in determining the quality of what we “design” and “plan”; using a light touch ensures we obtain a creative mix of good taste and balance.

We do not simply want to produce an item of furniture, we want to live with it.









MAZE

design Matteo Nunziati

Gli oggetti che esprimono umanità e intimità diventano la decorazione del nostro mondo, come un ponte che unisce linguaggi diversi, quello del relax e della libertà. Nelle righe di questo dinamico spartito l'inserimento degli arredi crea la musica del nostro tempo sospeso, quello dove ogni momento è dedicato al tempo libero.

The objects expressing humanity and intimacy become decoration of our world, like a bridge connecting different languages, that of relax and the one of freedom. Between the lines of this dynamic score the introduction of the furniture creates the music of our held time, when every single moment is dedicated to the spare time.



OBQ





PERGOLA si inserisce in una nuova dimensione creando un originale angolo sempre più personale e confortevole. Annullare i confini ci permette di vedere una realtà più ampia di quella vera usando strutture modernissime nel design, nidi del nostro relax dove vivere felici, puntando sulla qualità dei materiali. E' importante prestare attenzione alle piccole cose, quando l'arredamento occupa la totalità dello spazio e diventa più ingombrante del necessario, fare in modo che volumi ed arredi si armonizzino e creino un equilibrio che si mantiene anche nel loro trasformarsi.

PERGOLA enters in a new dimension creating an original corner more and more personal and comfortable. Facing borders allows us to see a larger reality than the true one, using modern structures, nests of our relax where living happy chosen targeting to the quality of materials. It is important to pay attention to small things, when furnishing fills the whole space and becomes bulkier than needed; make sure that volumes and furnishing harmonize and create a balance which keeps alive through the changes.







JUBEAE

design CDC

Un oggetto è un mezzo per personalizzare ancora di più la filosofia della vita, la ricerca del materiale e delle forme per identificare sempre più il proprio obiettivo tra ispirazione minimalista e creativa emozionalità, per proseguire il dialogo, molto trend, tra outdoor ed indoor.

An object which represents the means to add a further personal perspective of the philosophy of life, the research into materials and shapes, to guide towards an ever-increasing focus on its own objective of formally linking together minimalist and creative sensitivity, in order to find the consensus between those who wish to explore further the highly modern trend for a dialogue between indoor and outdoor spaces.



Sedia
Chair



Sedia con braccioli
Chair with arms



Poltrona
Armchair





L3

design Sergio Brioschi

Comfort e benessere per migliorare il tempo da dedicare alla vita privata. Design minimal e leggero gli aggettivi per questo prodotto caratterizzato dalle linee arrotondate, per rilassarsi e giocare con la fantasia leggendo piacevolmente un libro. L'emozione sensoriale nei colori, nei tessuti e nelle forme, è un gioco di oggetti che si armonizzano per unire sempre più indissolubilmente l'esterno con l'interno e viceversa, il desiderio di sostare, di riposare, e stare con gli amici, la nostra vita di relax.

Comfort and well-being to improve your free time. Minimal and light design these are the qualities of this product distinguished by its rounded lines, for relaxing and playing with fantasy reading a book. The sensory emotions of the colours, textiles and forms is an interplay of objects that harmonise to combine ever more inextricably outdoors with indoors (and vice versa) the desire to stop, rest, spend time with friends and enjoy relaxation.

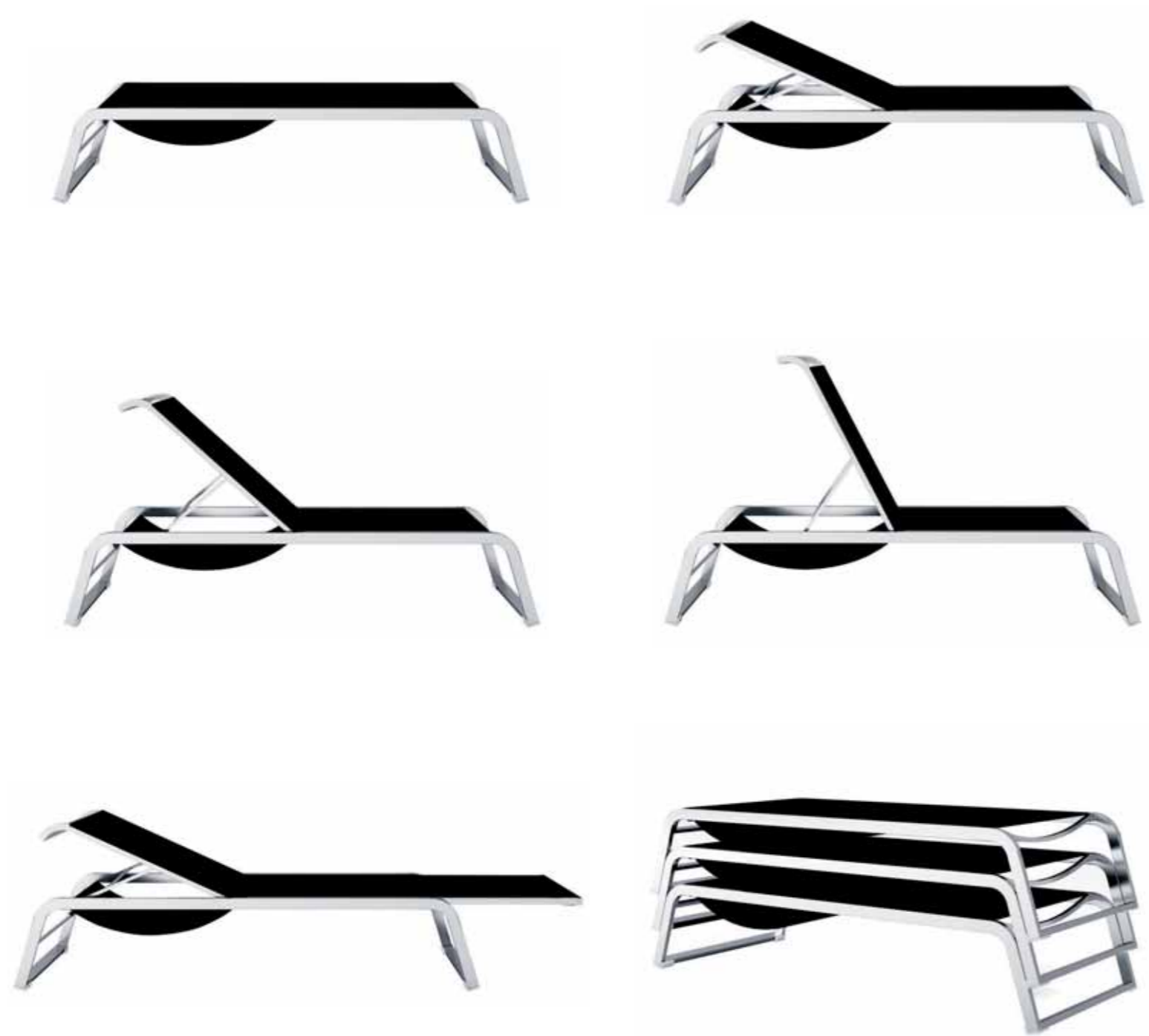

Lettino impilabile con parasole
Stackable sun lounger with sun-shade roof





SG1

design Stefano Gallizioli

La collezione prevede sedie con e senza braccioli, poltrona, divanetto, poltrona a dondolo, sgabelli, chaise longue, e lettino caratterizzate dalla struttura in acciaio inox satinato. Seduta e schienale in tondino di PVC rinforzato nylon, o in doghe di poliuretano rigido in diversi colori. SG1 comprende una serie di tavoli: rettangolari, quadrati e rotondi.

The collection offers chairs with or without armrests, armchairs, sofas, rocking armchairs, stools, chaises longues and sun loungers, characterised by their satin stainless steel frame. Seats and back rests come either in reinforced PVC nylon cord or stiff polyurethane slats in different colours. SG1 includes a series of rectangular, square and round tables.









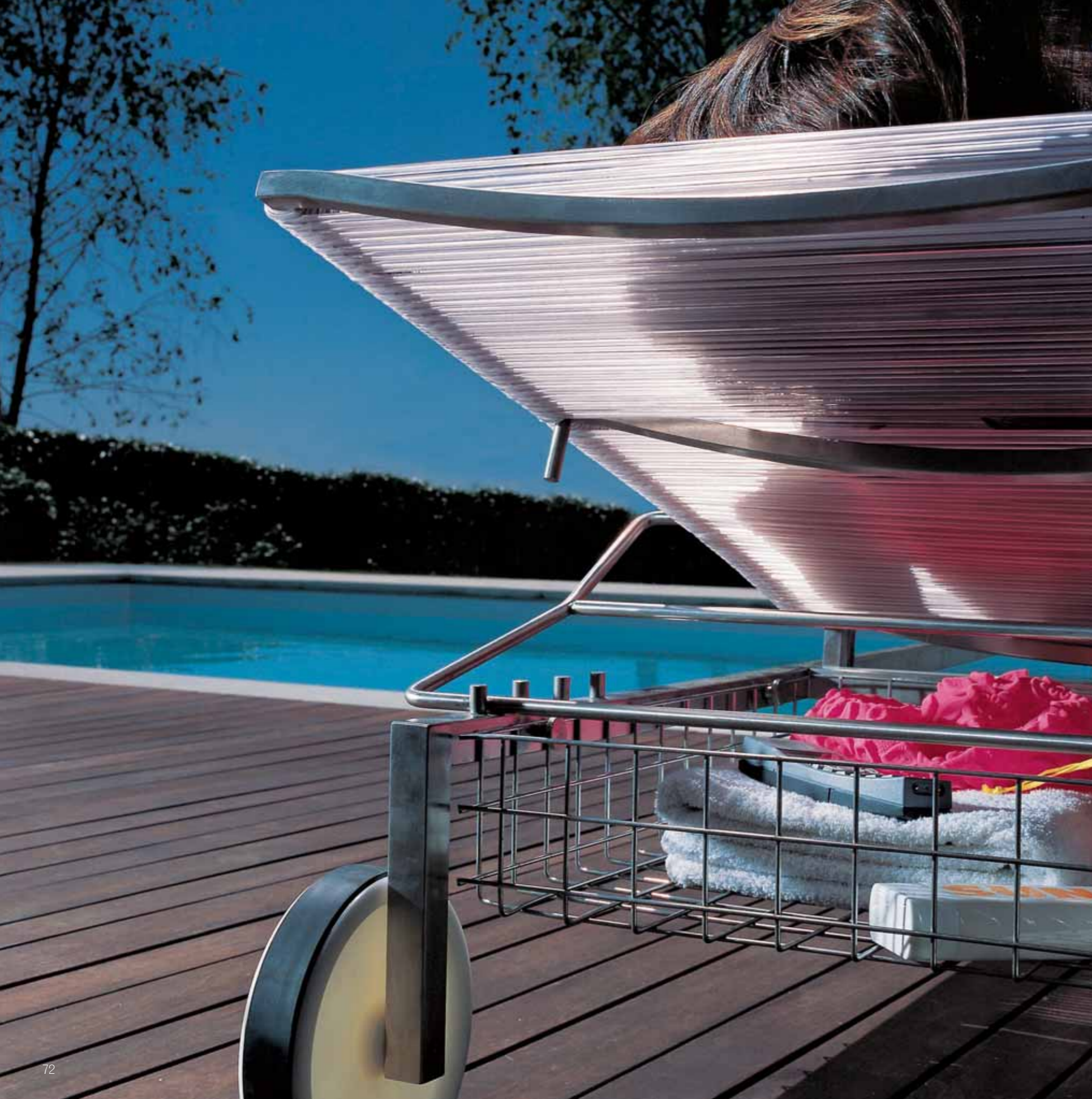



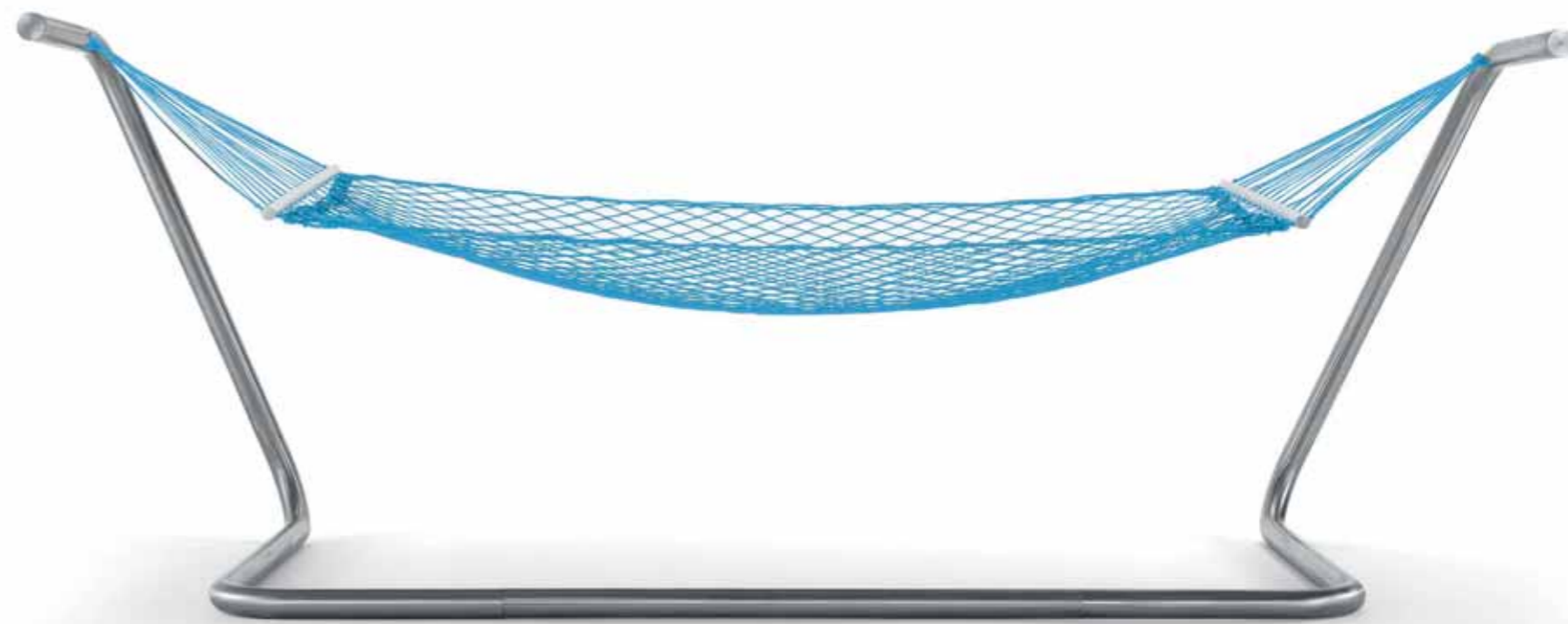









SHOT

design Stefano Gallizioli

Un tavolo diventa realtà attraverso un lavoro di progettazione, di definizione dell'immagine e di trasformazione industriale. Un oggetto che accompagna i diversi momenti della giornata, aggiungendo una nota di personalità, di grande libertà e di piacere, che sposa alla funzionalità un'eleganza sempre raffinata.

A table becomes reality through design, image definition and industrial processing. An object for various moments of the day, adding a personal and highly pleasing note, totally free of restrictions, combining practicality with unerringly sophisticated elegance.



Tavolo rettangolare in piano stratificato
Rectangular table in high thickness laminate



Tavolo quadrato alto in doghe di poliuretano rigido
Square dinner table in stiff polyurethane slats



ZETA

design James Irvine

Stare insieme è un piacere che si traduce nel piacere degli altri. La ricetta per rendere conviviale un momento di incontro non può che essere personale. Di certo, nel gioco degli elementi che si combinano per creare un ambiente informale, gli oggetti hanno un ruolo essenziale: presenze opportune e discrete, supporti gradevoli e adattabili al contesto. Così abbiamo voluto ZETA, la linea che realizza un criterio assolutamente originale di mobile pieghevole e riponibile. Sedie e tavoli che si installano e si rimettono a posto con sorprendente facilità. Perché ordine e disordine sono composti dagli stessi elementi. Diversamente disposti.

Togetherness is a pleasure that is found in the pleasure of others. The art of making a shared moment cherishable is nothing if not highly personal. One thing is sure: in the masterful combination of elements that create an informal ambiance, objects are paramount: they need to be appropriate, discreet and pleasant props that adapt to the context. This is why we wanted to make ZETA, a line that embodies an absolutely original idea for fold-and-stow furniture. Chairs and tables that are amazingly easy to set up and put away. You see, order and disorder are made up of the same elements. Just differently arranged.



Sedia pieghevole impilabile
Stackable folding chair



Tavolo rotondo
Round table



Tavolo quadrato
Square table



FELLINI

design Stefano Gallizioli

Interni ed esterni, tra questi ambiti si svolge la trama di un film, o il succedersi dei tempi, in un alternarsi di sequenze e di situazioni. Ciascuno ne dà la più personale interpretazione. Noi pensiamo che la scena mobile della vita, in casa o all'aperto, chieda una regia dinamica, sensibile ed al tempo stesso rilassata. per questo abbiamo dato il nome di Fellini a una linea che ha come motivo portante la rielaborazione in acciaio inox della tradizionale sedia da regista per ampliarsi in una collezione di sedute. Novità del disegno, tecnica costruttiva e varietà dei materiali tradotte in comfort e versatilità. Di valori concreti è fatta "La dolce vita".

Indoors and outdoors, the plot of a movie, or the passage of the time, takes place between these two scenarios alternating scenes and situations. Each of us gives his own personal interpretation. We believe that the mobile scene of life, whether inside or outside, requires a dynamic, sensitive and, at the same time, easy-going direction. This is the reason we have given the name of Fellini to a collection which has as its main theme the revamping of the traditional director's chair in stainless steel and which develops the seating collection further. Innovations in design, construction technique and variety of materials translate into comfort and versatility. From solid values comes "La dolce vita".





LOOP

design Gala Wright



Chaise longue pieghevole
Folding chaise longue



DOCCIA/SHOWER

design Danny Venlet

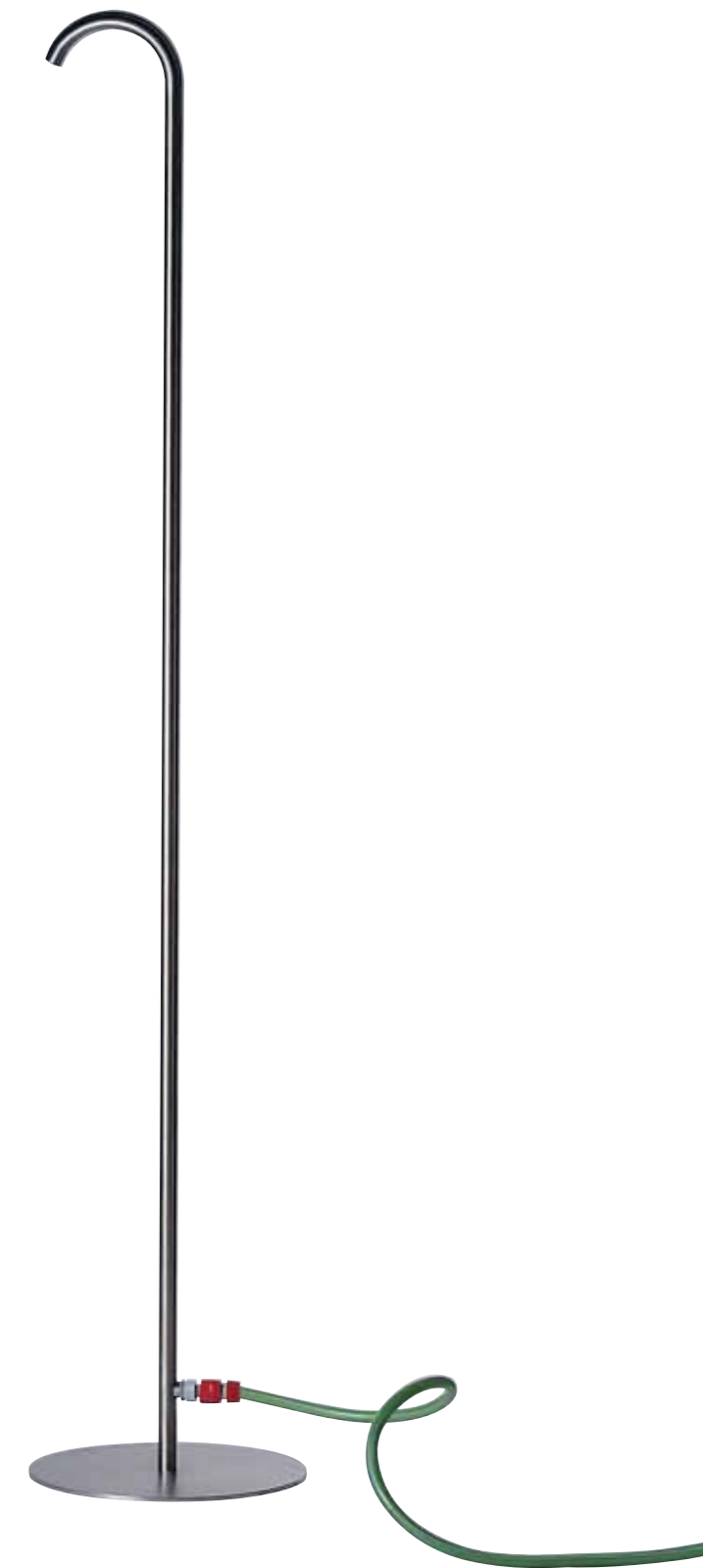



BBQ

design Stefano Gallizioli



Barbecue a gas con pietre laviche
Gas barbecue with volcanic rocks



DISEGNI TECNICI / TECHNICAL DRAWINGS



Divano circolare / Circular sofa

Schienale rivestito in pvc rinforzato.
Cuscino seduta con imbottitura in poliuretano dryfeel.
Rivestimento sfoderabile in tessuto Garden.
Copertura per divano Nest tessuto Tessil.

Back rest in reinforced pvc nylon.
Seat cushion in dryfeel polyurethane pad.
Upholstery removable Garden fabric.
Tessil fabric cover for Nest sofa.

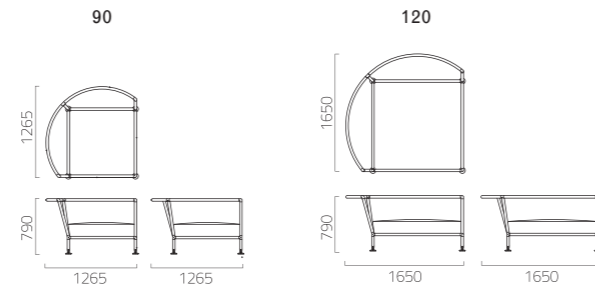

pp. 12-13



Divano lineare / Linear sofa

Schienale rivestito in pvc rinforzato.
Cuscino seduta con imbottitura in poliuretano dryfeel.
Rivestimento sfoderabile in tessuto Garden.
Copertura per divano Nest tessuto Tessil.

Back rest in reinforced pvc nylon.
Seat cushion in dryfeel polyurethane pad.
Upholstery removable Garden fabric.
Tessil fabric cover for Nest sofa.

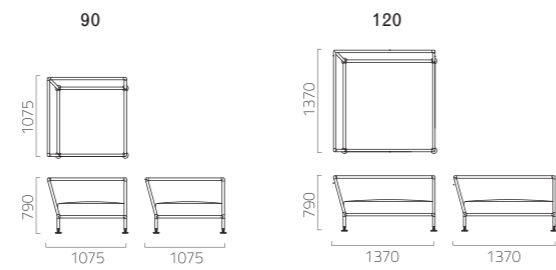

pp. 6-7



Divano dx-sx / Sofa dx-sx

Schienale rivestito in pvc rinforzato.
Cuscino seduta con imbottitura in poliuretano dryfeel.
Rivestimento sfoderabile in tessuto Garden.
Copertura per divano Nest tessuto Tessil.

Back rest in reinforced pvc nylon.
Seat cushion in dryfeel polyurethane pad.
Upholstery removable Garden fabric.
Tessil fabric cover for Nest sofa.

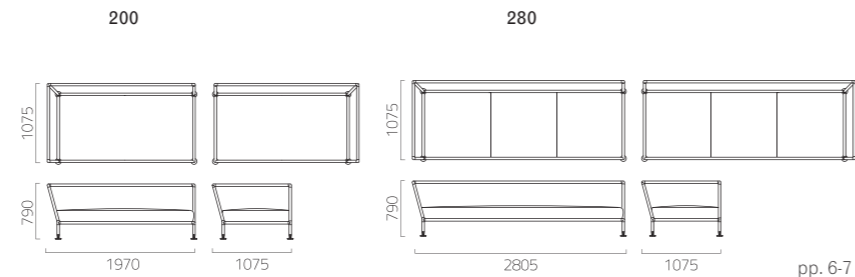

pp. 6-7



Elemento centrale / Central component

Schienale rivestito in pvc rinforzato.
Cuscino seduta con imbottitura in poliuretano dryfeel.
Rivestimento sfoderabile in tessuto Garden.
Copertura per divano Nest tessuto Tessil.

Back rest in reinforced pvc nylon.
Seat cushion in dryfeel polyurethane pad.
Upholstery removable Garden fabric.
Tessil fabric cover for Nest sofa.

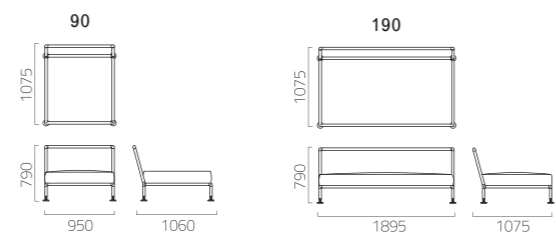

Chaise longue

Schienale rivestito in pvc rinforzato nylon.
Cuscini con imbottitura in poliuretano dryfeel.
Rivestimento sfoderabile in tessuto Garden.
Copertura per divano Nest tessuto Tessil.

Back rest in reinforced pvc nylon.
Cushions in dryfeel polyurethane pad.
Upholstery removable Garden fabric.
Tessil fabric cover for Nest sofa.

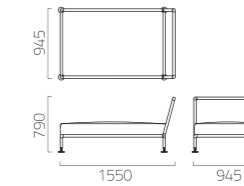

pp. 18-19



Chaise longue dx - sx

Schienale rivestito in pvc rinforzato nylon.
Cuscini con imbottitura in poliuretano dryfeel.
Rivestimento sfoderabile in tessuto Garden.
Copertura per divano Nest tessuto Tessil.

Back rest in reinforced pvc nylon.
Cushions in dryfeel polyurethane pad.
Upholstery removable Garden fabric.
Tessil fabric cover for Nest sofa.

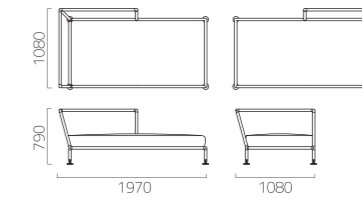

Divano Lineare / Linear sofa

Schienale rivestito in pvc rinforzato.
Cuscino seduta con imbottitura in poliuretano dryfeel.
Rivestimento sfoderabile in tessuto Garden.
Copertura per divano Nest tessuto Tessil.

Back rest in reinforced pvc nylon.
Seat cushion in dryfeel polyurethane pad.
Upholstery removable Garden fabric.
Tessil fabric cover for Nest sofa.

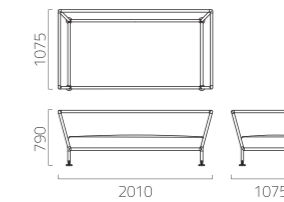

Divano Lineare / Linear sofa

Schienale rivestito in pvc rinforzato.
Cuscino seduta con imbottitura in poliuretano dryfeel.
Rivestimento sfoderabile in tessuto Garden.
Copertura per divano Nest tessuto Tessil.

Back rest in reinforced pvc nylon.
Seat cushion in dryfeel polyurethane pad.
Upholstery removable Garden fabric.
Tessil fabric cover for Nest sofa.

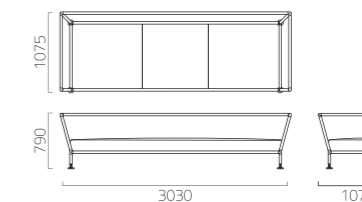



Pouf / Ottoman

Cuscino seduta con imbottitura in poliuretano dryfeel.
Rivestimento sfoderabile in tessuto Garden.
Copertura per divano Nest tessuto Tessil.

Seat cushion in dryfeel polyurethane pad.
Upholstery removable Garden fabric.
Tessil fabric cover for Nest sofa.

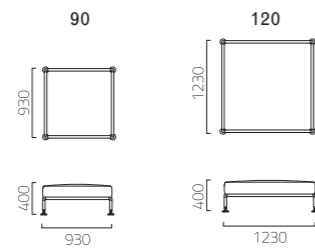

Poltrona / Armchair

Seduta e schienale rivestito in PVC rinforzato nylon.
Cuscini con imbottitura in poliuretano dryfeel.
Rivestimento sfoderabile in tessuto Garden.

Seat and back rest in reinforced PVC nylon.
Cushions in dryfeel polyurethane pad.
Upholstery removable Garden fabric.

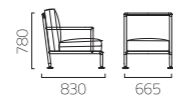

pp. 20-21

Cuscino schienale divano / Back cushion

Imbottitura in poliuretano dryfeel.
Rivestimento sfoderabile in tessuto Garden.

Dryfeel polyurethane pad.
Upholstery Garden fabric.

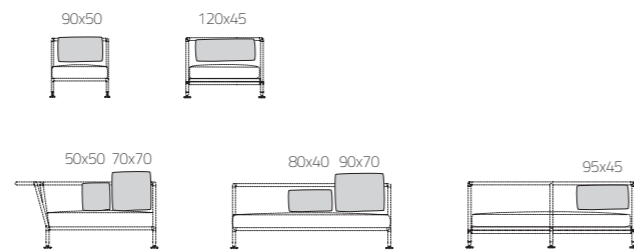

Sedia / Chair

Seduta e schienale rivestito in PVC rinforzato nylon.
Cuscino seduta tessuto Garden.
Cuscino seduta e schienale tessuto Garden.

Seat and back rest in reinforced PVC nylon.
Seat cushion Garden fabric.
Seat and back cushion Garden fabric.

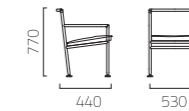

pp. 22-23



Tavolo rettangolare / Rectangular table

Piano in alluminio verniciato o quarzo a spacco.

Varnished aluminium or "slate looking" quartz stone top.

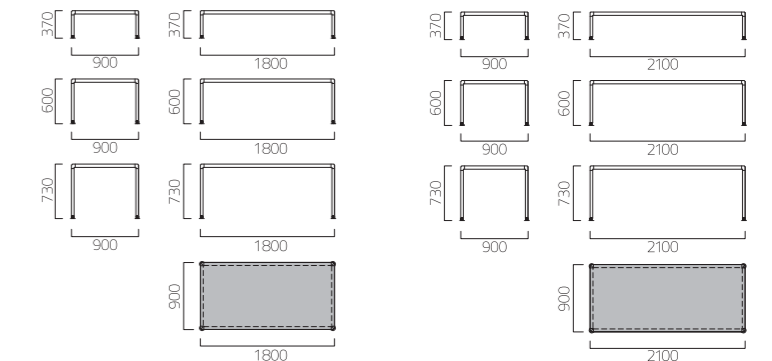

Tavolo quadrato / Square table

Piano in alluminio verniciato o quarzo a spacco.

Varnished aluminium or "slate looking" quartz stone top.

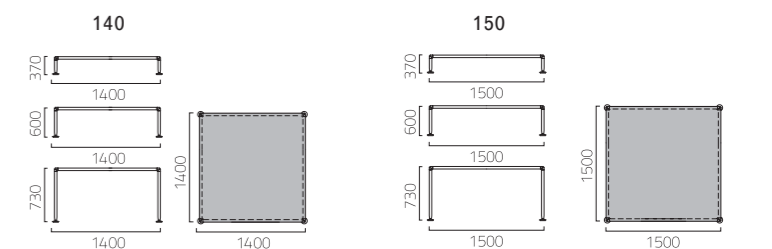

I tavoli Nest possono essere realizzati su misura / Custom-made Nest tables available on request



Tavolino rettangolare / Rectangular low table

Piano alluminio verniciato.
Piano trafficstone wave.

Top varnished aluminium.
Top trafficstone wave.

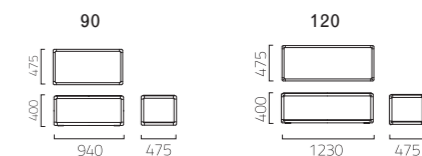



Cuscini seduta e schienale con imbottitura in poliuretano dryfeel.
Rivestimento sfoderabile in tessuto Garden.
Piano dei tavoli in marmo, alluminio verniciato.

Seat and back rest cushion in dryfeel polyurethane pad.
Upholstery removable Garden fabric.
Marble, varnished aluminium table top.

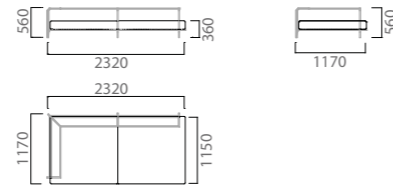

pp. 26-29



Poltrona 100 / Armchair 100

Imbottitura per uso interno o dryfeel per uso esterno.
Rivestimento sfoderabile in tessuto Garden.
Piano d'appoggio in acciaio inox satinato, possibilità luce a led.

Padding for indoor or dryfeel padding for outdoor.
Garden fabric cover. Brushed stainless steel table.
Led lighting available (on fixed table).

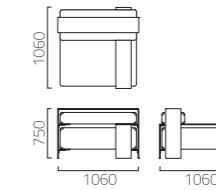

pp. 32-33

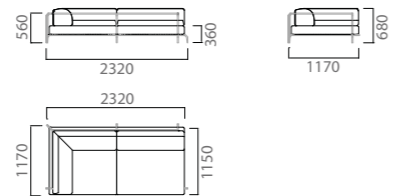

Divano singolo 200 / Single sofa 200

Imbottitura per uso interno o dryfeel per uso esterno.
Rivestimento sfoderabile in tessuto Garden.
Piano d'appoggio in acciaio inox satinato, possibilità luce a led.

Padding for indoor or dryfeel padding for outdoor.
Garden fabric cover. Brushed stainless steel table.
Led lighting available (on fixed table).

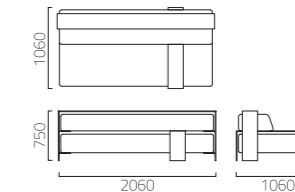

pp. 32-33



Divano doppio 400 / Double sofa 400

Imbottitura per uso interno o dryfeel per uso esterno.
Rivestimento sfoderabile in tessuto Garden.
Piano d'appoggio in acciaio inox satinato, possibilità luce a led.

Padding for indoor or dryfeel padding for outdoor.
Garden fabric cover. Brushed stainless steel table.
Led lighting available (on fixed table).

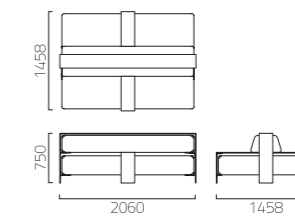

pp. 32-33

OBQ / OPQ

Struttura in acciaio inox satinato
Brushed stainless steel frame



OBQ 3-4

Ombrellone quadrato in tessuto Tex.
Square sunshade in Tex fabric.

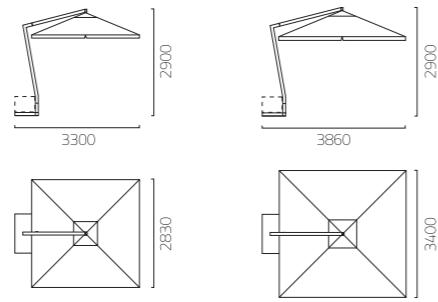

pp. 34-37



OPQ 3-4

Ombrellone quadrato in tessuto Tex con palo centrale.
Square sunshade in Tex fabric with central arm.

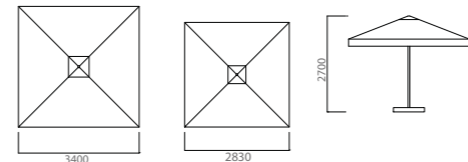

pp. 34-37

FIORIERE

Struttura in acciaio inox satinato
Brushed stainless steel frame



Fioriere / Flower pots

Rivestimento interno in Enkadrain.
Disponibili anche nella versione con ruote.

Equipped inside with an insulating material called Enkadrain.
Available also with carrying wheels.

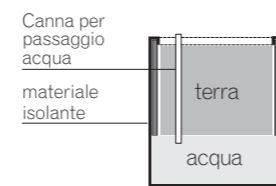
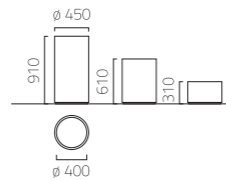

pp. 102

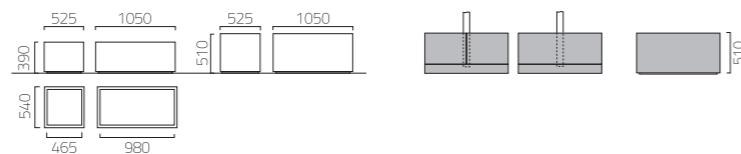

Le fioriere possono essere realizzate su misura.
Custom-made flower pots available on request.

PERGOLA

Struttura in acciaio inox satinato
Brushed stainless steel frame



Pergola singola / Single pergola

Copertura doghe in stratificato e tende ombreggianti.
Roof with slats of high thickness laminate and dining curtains.

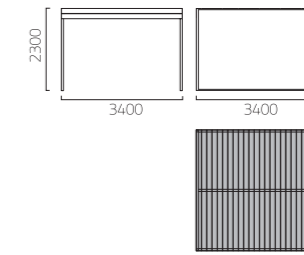

pp. 38-41



Pergola doppia / Double pergola

Copertura doghe in stratificato e tende ombreggianti.
Roof with slats of high thickness laminate and dining curtains.

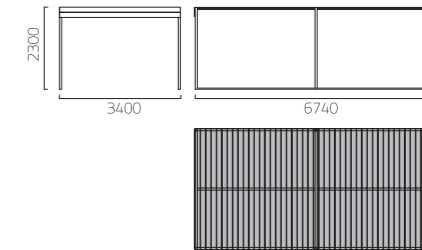

Le pergole possono essere realizzate su misura / Custom-made pergola available on request

DOCCIA

Struttura in acciaio inox satinato
Satin stainless steel frame



Doccia / Shower

Doccia dotata di diffusore.
Shower with nebulizer.





Sedia impilabile / Stackable chair

Seduta e schienale intrecciati tondino PVC o cordino acrilico.
PVC or acrylic cord woven seat and backrest.



pp. 42-45



Sedia con braccioli impilabile / Stackable chair with arms

Seduta e schienale intrecciati tondino PVC o cordino acrilico.
PVC or acrylic cord woven seat and backrest.

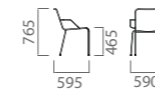

Poltroncina impilabile / Stackable small armchair

Seduta e schienale intrecciati tondino PVC o cordino acrilico.
PVC or acrylic cord woven seat and backrest.

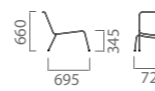

Tavolino quadrato / Small square table

Piano in alluminio verniciato bianco o tortora.
Varnished aluminium top white or taupe.

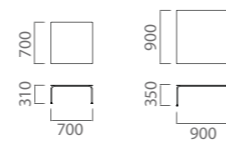

Lettino impilabile / Stackable sun lounger

Seduta, schienale e poggiatesta in tessuto Sun.
Schienale regolabile.
Poggiatesta allungabile, scorrevole e a scomparsa.

Seat and backrest in Sun fabric.
Adjustable backrest.
Extensible sliding footrest.

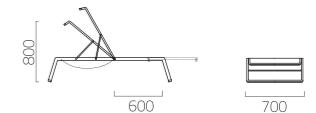

pp. 53



Lettino impilabile con parasole / Stackable sun lounger with sun-shade roof

Seduta, schienale e poggiatesta in tessuto Sun.
Schienale regolabile.
Poggiatesta allungabile, scorrevole e a scomparsa.

Seat and backrest in Sun fabric.
Adjustable backrest.
Extensible sliding footrest.

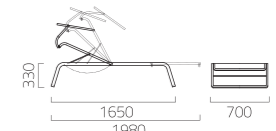

pp. 55



Tavolino / Small table

Rettangolare verniciato arancio;
quadrato verniciato bianco.

Rectangular varnished orange;
square varnished white.

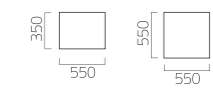

pp. 49



Contenitore L3 con tavolino scorrevole in alluminio colore grigio tortora.

Container L3 table with aluminum sliding dove-grey colour.

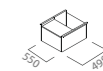

pp. 57

S**Sedia senza braccioli impilabile a gruppi di 6 /
Stackable chair without arms - up to 6**

Seduta e schienale intrecciati tondino PVC, cordino acrilico, o in doghe di poliuretano rigido.
Possibilità cuscino seduta in tessuto Tex o Garden.

PVC, acrylic cord woven or stiff polyurethane slat seat and backrest.
Seat cushion available in Garden or Tex fabric.

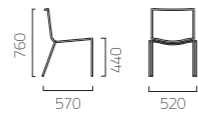

pp. 60-61

SB**Sedia con braccioli / Chair with arms**

Seduta e schienale intrecciati tondino PVC, cordino acrilico, o in doghe di poliuretano rigido.
Possibilità cuscino seduta in tessuto Tex o Garden.

PVC, acrylic cord woven or stiff polyurethane slat seat and backrest.
Seat cushion available in Garden or Tex fabric.

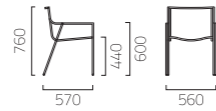

pp. 60-61

SGA**Sgabelli impilabili a gruppi di 6 /
Stackable stools - up to 6 items**

Seduta intrecciata tondino PVC o cordino acrilico.

PVC or acrylic cord woven seat.



pp. 70

D**Divanetto / Sofa**

Seduta e schienale intrecciati tondino PVC o cordino acrilico

PVC or acrylic cord woven seat and backrest.

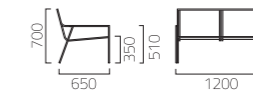

pp. 64

P**Poltrona / Armchair**

Seduta e schienale intrecciati tondino PVC, cordino acrilico o in doghe di poliuretano rigido.
Possibilità cuscino seduta in tessuto Tex o Garden.

PVC, acrylic cord woven or stiff polyurethane slats seat and backrest. Seat cushion available in Garden or Tex fabric.



pp. 63

PD**Poltrona a dondolo / Rocking armchair**

Seduta e schienale intrecciati tondino PVC o cordino acrilico

PVC or acrylic cord woven seat and backrest.

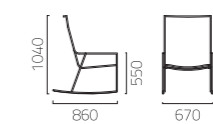

pp. 65



CL
Chaise longue

Seduta e schienale intrecciati tondino PVC o cordino acrilico.

PVC or acrylic cord woven seat and backrest.

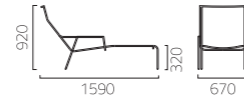

pp. 67

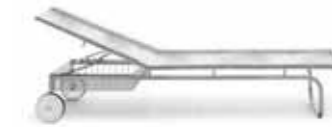

L
Lettino / Sun lounger

Seduta e schienale intrecciati tondino PVC o cordino acrilico.

PVC or acrylic cord woven seat and backrest.

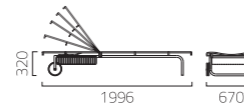

pp. 69



AM
Amaca / Hammock

Amaca in rete o in tessuto Tex.

Rope hammock or Tex fabric.

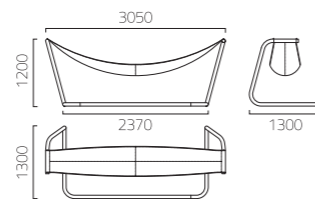

pp. 72-73



TR
Tavolo rettangolare / Rectangular table

Piano stratificato o in doghe di poliuretano rigido.

High tickness laminate or stiff polyurethane slat top.

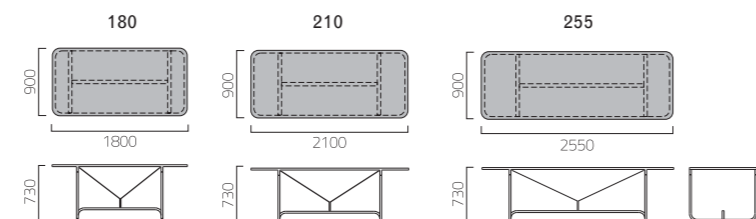

pp. 75



TQ
Tavolo quadrato / Square table

Piano stratificato o in doghe di poliuretano rigido.

High tickness laminate or stiff polyurethane slat top.

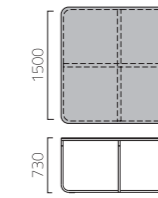

pp. 77



TO
Tavolo rotondo / Round table

Piano stratificato o in doghe di poliuretano rigido.

High tickness laminate or stiff polyurethane slat top.

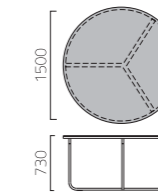

pp. 76



TQb
Tavolino quadrato basso / Small square low table

Piano stratificato o in doghe di poliuretano rigido.

High tickness laminate or stiff polyurethane slat top.

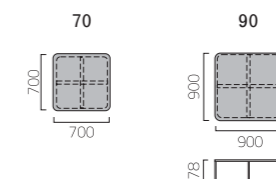

pp. 78



TOb
Tavolo rotondo basso / Small round low table

Piano stratificato o in doghe di poliuretano rigido.

High tickness laminate or stiff polyurethane slat top.

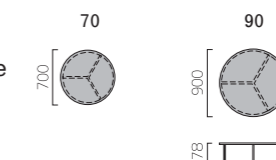

pp. 79

SHOT

Struttura in acciaio inox satinato
Brushed stainless steel frame



Tavolo rettangolare / Rectangular table

Piano stratificato, in doghe di poliuretano rigido, o pietra Zimbabwe.

High thickness laminate, stiff polyurethane slat, or black Zimbabwe stone top.

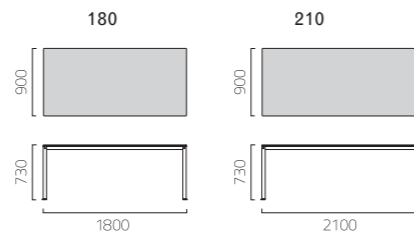

pp. 81



Tavolo quadrato / Square table

Piano stratificato, in doghe di poliuretano rigido, o pietra Zimbabwe.

High thickness laminate, stiff polyurethane slat, or black Zimbabwe stone top.

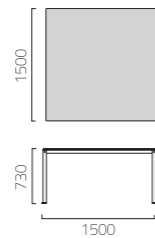

pp. 80-85



Tavolo quadrato basso / Square low table

Piano stratificato, in doghe di poliuretano rigido, o pietra Zimbabwe.

High thickness laminate, stiff polyurethane slat, or black Zimbabwe stone top.

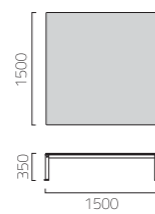

Tavolino quadrato basso / Small square low table

Piano stratificato, in doghe di poliuretano rigido, o pietra Zimbabwe.

High thickness laminate, stiff polyurethane slat, or black Zimbabwe stone top.

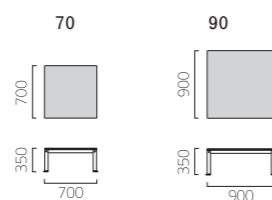

ZETA

Struttura in acciaio inox satinato
Brushed stainless steel frame



Sedia / Chair

Pieghevole e impilabile. Seduta in poliesteri.

Folding and stackable. Seat in polystyrene.

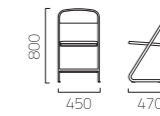

pp. 87-88



Tavolo quadrato e rotondo / Square and round table

Pieghevole. Piano stratificato.

Folding. Top in high thickness laminate.

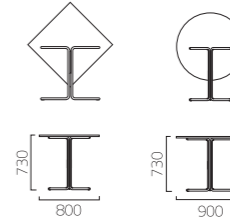

pp. 90-91

FELLINI

Struttura in acciaio inox satinato
Brushed stainless steel frame



Sedia regista / Director chair

Seduta e schienale in tessuto Leaf o Garden.

Seat and backrest in Leaf or Garden fabric.

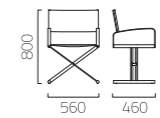

pp. 92-95



Sgabello / Stool

Seduta in tessuto Leaf o Garden.

Seat in Leaf or Garden fabric.

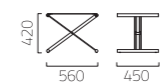

LOOP

Struttura in acciaio inox satinato
Brushed stainless steel frame



Chaise longue pieghevole / Folding chaise longue

Seduta in tessuto Leaf.

Seat in Leaf fabric.

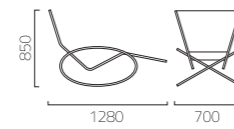

pp. 98

BBQ

Struttura in acciaio inox satinato
Brushed stainless steel frame



Barbecue a gas con pietre laviche / Gas barbecue with volcanic rocks

Vano chiuso per alloggiamento bombola a gas, tagliere in faggio e contenitore rifiuti. Attrezzabile con: griglia doppia, copertura.

Gas cylinder storage cabinet, chopping board in beech wood and refuse container. Equippable with: double grill, cover.

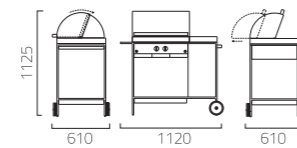

pp. 102

